

### Products

Channel MS 27-1.25

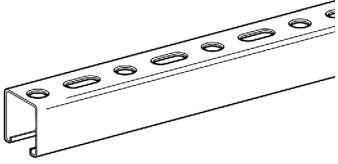

Cantilever Bracket AK 27-1.25

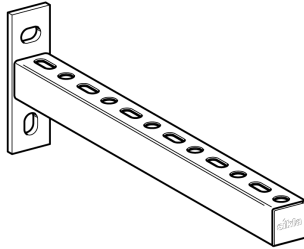

End Cap ADK 27

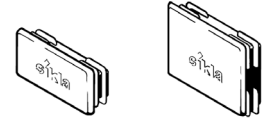

Blockset PBS CC 27



Speed Nut NT CC 27  
Block PB 27

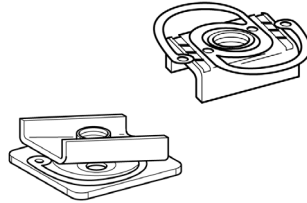

Channel Holder MOF 27

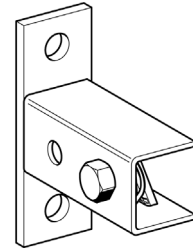

90° Angle Connector CN CC 27



Web Plate KNO

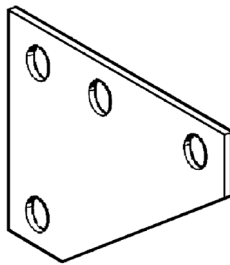

T Bracket MOS 27

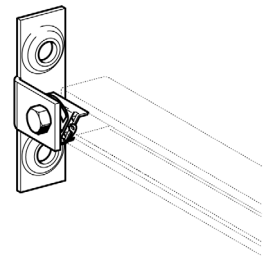

Beam Clamp SB 27

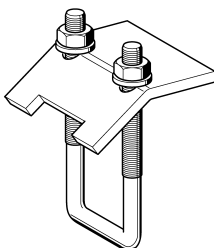

Holding Bracket HK 27

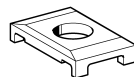

Channel Lining SAL 27  
Sound Absorption Unit SDE 27

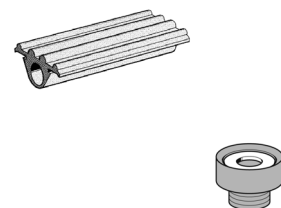

### Connection to the building structure

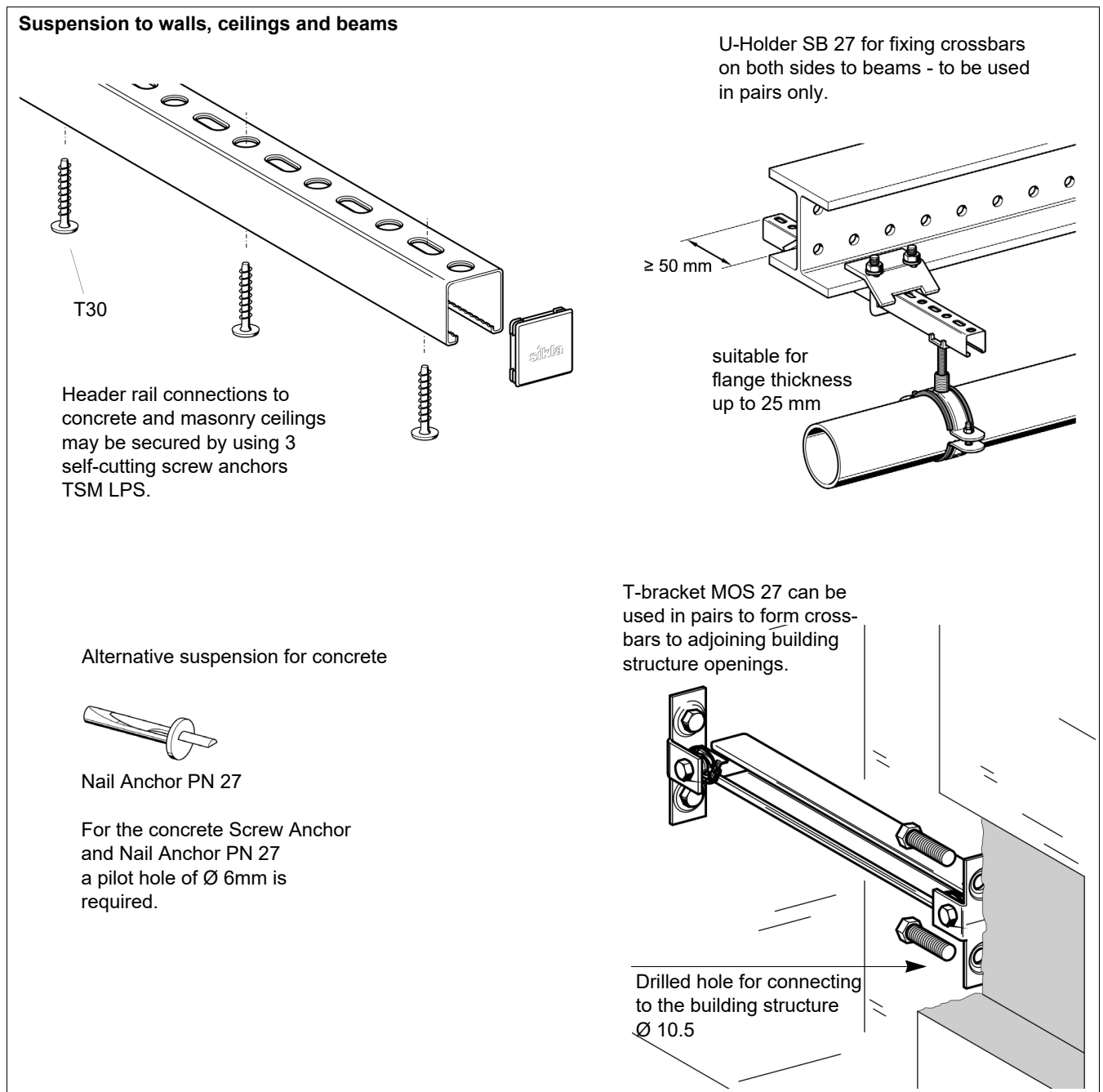
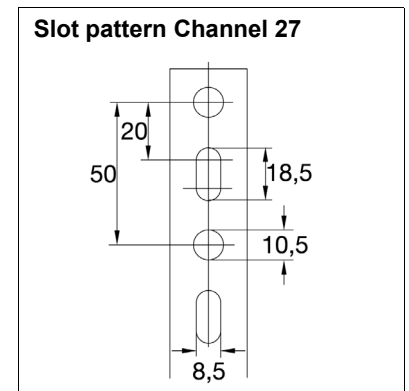
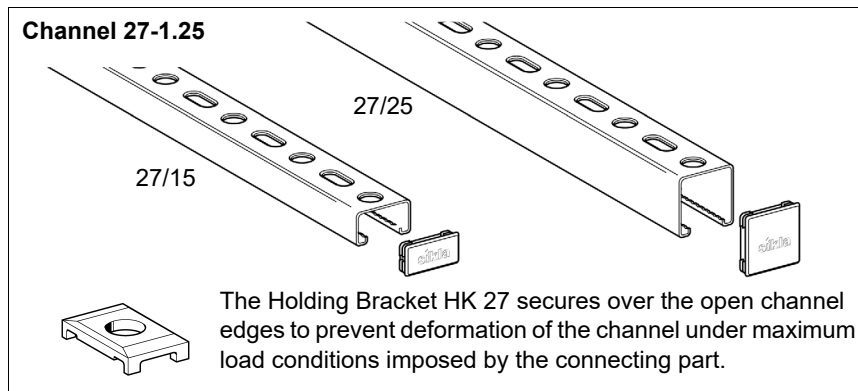

### Fixing Brackets and Frames

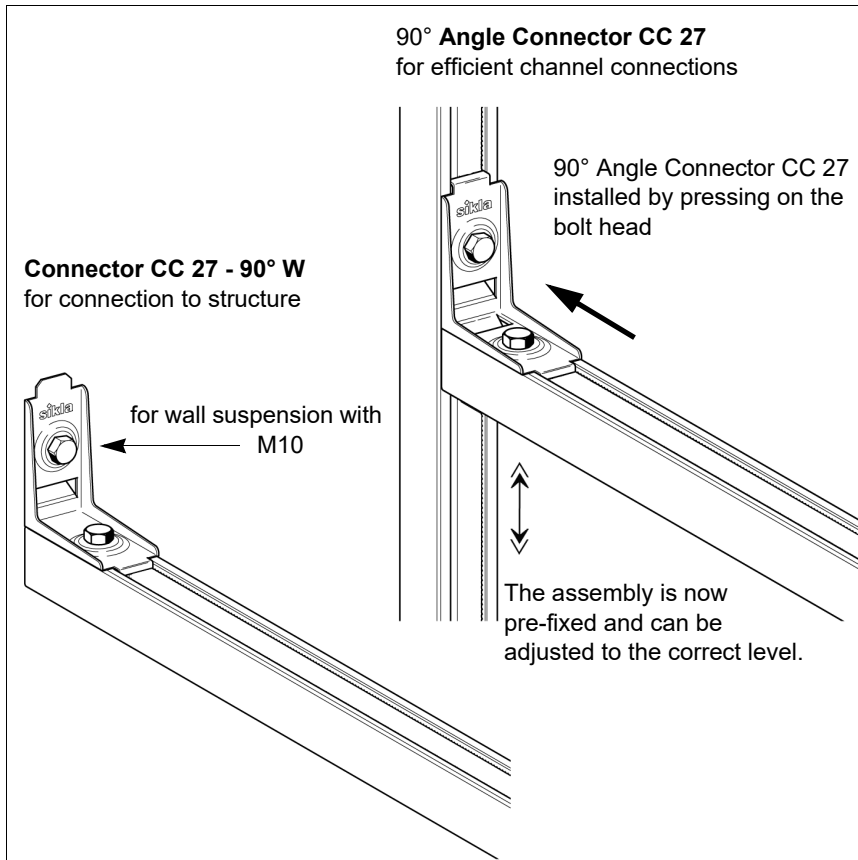
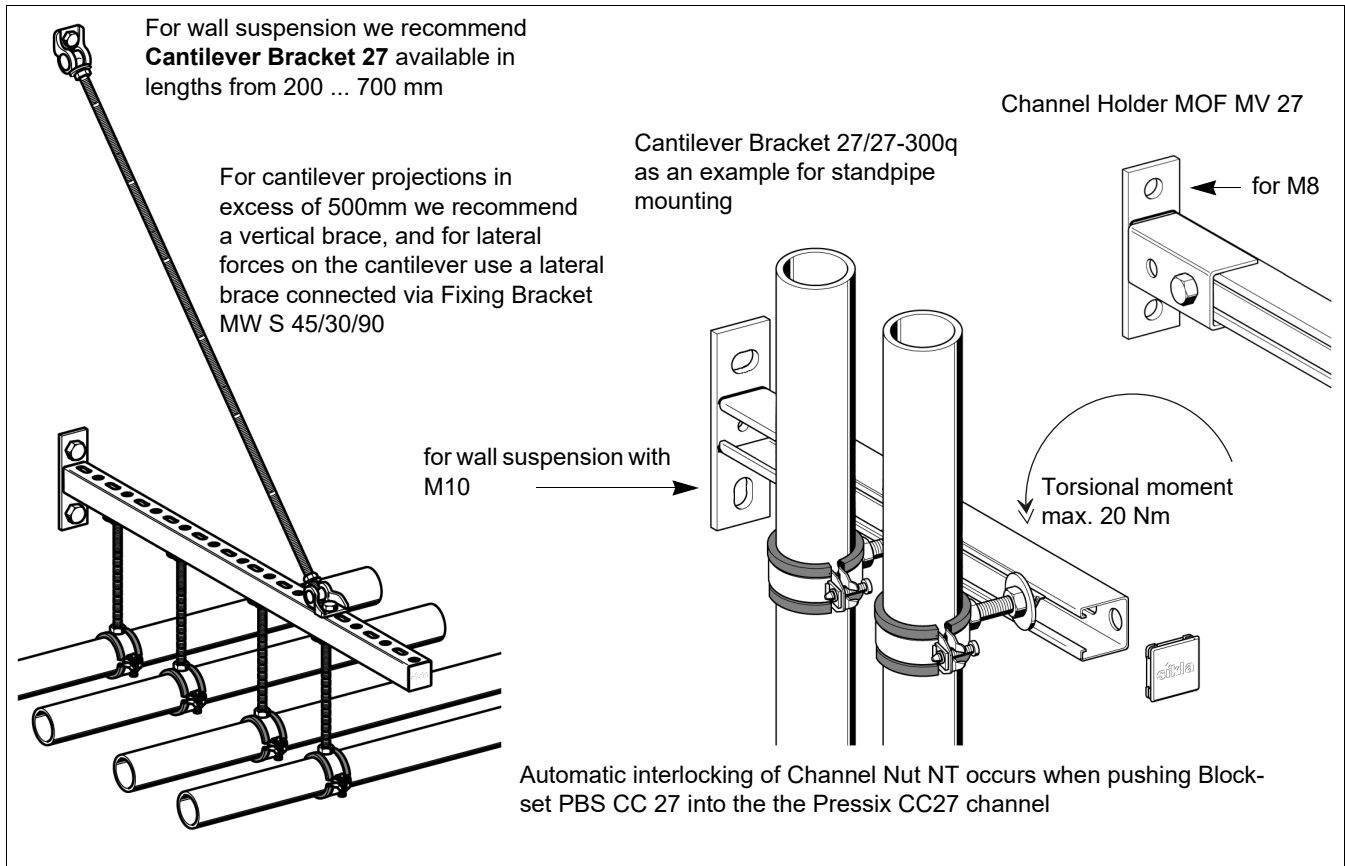

Your benefits using Pressix CC 27:

- ◆ Simple brackets and frame structures for small and medium loads guarantee an efficient installation of building services.
- ◆ From already 3 pipelines, costs can be reduced by using Pressix.
- ◆ An innovative fixing concept based on pre-assembled components reduces installation costs by up to 50%.

### Connecting to Channels

**1** By pressing, the CC-Parts turn into position automatically.

Speed nut NT CC 27  
M6, M8, M10

Block PB  
27 M8

Blockset PBS CC 27  
M8, M10

Slots in distances of 10mm enables cutting with Rod Cutter CUT PBC 1.

Grooved Rods GES PNS are available in incremental lengths up to 1000mm.

**2** When positioned into the Channel, a 'click' sound can be heard. At this stage the assembly can still be adjusted. Before securing the assembly to the channel, the height of the Grooved Rod GES PNS can be adjusted by winding in and out of the channel profile.

**3** The Grooved Rod can be cut to length before or after fixing. The cutting grooves ensure the thread won't be damaged. The pipe clamps can be installed without additional deburring of the rod.

**Caution!**

▶ Rod Cutter CUT PBC 1 has been developed especially for cutting Grooved Rod GES PNS M8 and M10. It shouldn't be used for anything else.

Off-cuts can be used as further threaded studs rather than discarded.

**4** Final fixing, length indication for Blockset PBS CC27 Channel edge up to the end of the grooved rod.

For wall suspension we recommend Cantilever Bracket AK 27 available in lengths from 200 ... up to 800 mm.

Advantages by using Pressix:

- ◆ less parts  
= less orders  
= less searching  
= less confusion.
- ◆ Neither electricity nor special tools are needed for assembly.
- ◆ Pipe supports are generated in just a few easy steps. Apart from the fact that it saves you time and the bother with small parts, it also is amusing!

**Note:**

▶ Compatibility within the system only when using Sikla connection elements 27.